



2001-2007 GM 2500HD Short Box 3B Mount Instructions

Step 1 – Lay out Ebling parts and hardware to familiarize yourself with contents.

Step 2 – Remove wire loom clips from factory hitch or any wire looms that may interfere with removal of factory hitch.

Step 3 – Remove 4 factory bolts from front of existing hitch, 2 on each side (these will not be reused). Support hitch and remove 2 remaining bolts from rear of hitch, 1 on each side (these will be reused). Slowly lower hitch and set aside.

Step 4 – Remove bolt clips from inside frame rails from front hitch bolts (these will not be reused).

Step 5 – Raise Ebling mount into position against frame, re-use factory bolts from rear of hitch, 1 each side, finger tighten only.

Step 6 – Put 1 hole backer plates inside frame rails at front of hitch, place 2 - ½" x 1 ¾" bolts through backer plate, frame and mount, finish with ½" flat washers, lock washers and nuts. 1 each side, finger tighten only.

Step 7 – Depending on actual frame, you may need to drill a 9/16" hole in frame for second holes in front side of mount, in these holes place a ½" x 1 ¾" bolt and grd8 flat washer through frame and mount. Finish with ½" flat washers, lock washers and nuts. 1 each side.

Step 8 – Make sure mount is centered on frame and tighten all 6 bolts to torque specifications shown on chart.

Step 9 – Now remove 2 bumper bracket nuts from left side of frame, place side support plate over bolts and mark holes to be drilled in plate.



Step 10 – drill 2- 9/16” holes as marked on plate, place plate over bumper bracket bolts and start nuts. Put ½” x 1 ½’ bolts from outside in through mount and side plate, finish with ½” lock washers and nuts. Finger tighten.

Step 11 – Repeat step 9 on right side.

Step 12 – Making sure the bumper is level and centered, tighten all bumper bracket bolts and side support plate bolts to torque specifications on chart.

* All parts and hardware included for the 3B mount must be used in the installation. Any missing or non-OEM parts or hardware will void warranty.



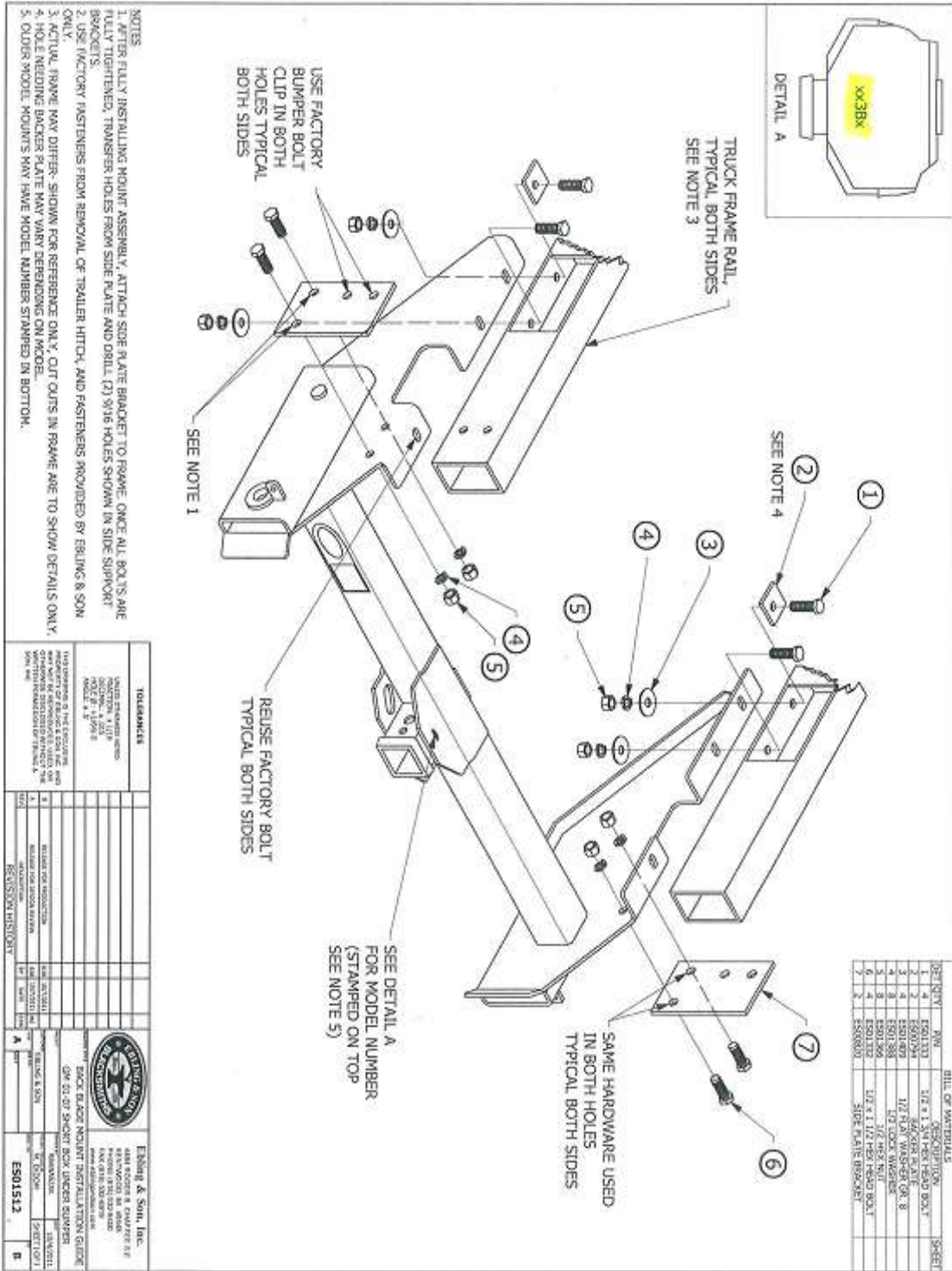

Installation of mount is complete.





TORQUE SPECIFICATIONS

BEFORE DRIVING YOUR VEHICLE, YOU SHOULD CHECK THE TORQUE ON ALL NUTS AND BOLTS IN THE KIT, INCLUDING ANY SLIDER BOLTS ON THE CALIPERS. RE-TORQUE CALIPER BOLTS AFTER 500 MILES. ALL SPECIFICATIONS ARE IN FT-LBS.

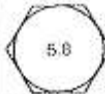
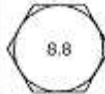
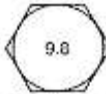
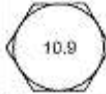
BOLT GRADES				
U.S.	SAE 2 	SAE 5 	SAE 7 	SAE 8 
Metric	5.8 	8.8 	9.8 	10.9 
Steel Type	Low Carbon (soft)	Medium Carbon Heat Treat	Medium Carbon Alloy	Medium Carbon Alloy

SAE	Bolt Grade	2	2	5	5	7	7	8	8	Socket Head Cap Screw	Socket Head Cap Screw
Bolt Dia.	Thread per inch	Dry	Oiled	Dry	Oiled	Dry	Oiled	Dry	Oiled	Dry	Oiled
1/4"	20	4	3	8	6	10	8	12	9	14	11
1/4"	28	6	4	10	7	12	9	14	10	16	13
5/16"	18	9	7	17	13	21	16	25	18	29	23
5/16"	24	12	9	19	14	24	18	29	20	33	26
3/8"	16	16	12	30	23	40	30	45	35	49	39
3/8"	24	22	16	35	25	45	35	50	40	54	44
7/16"	14	24	17	50	35	60	45	70	55	76	61
7/16"	20	34	26	55	40	70	50	80	60	85	68
1/2"	13	36	31	75	55	95	70	110	80	113	90
1/2"	20	52	42	90	65	100	80	120	90	126	100
9/16"	12	52	42	110	80	135	100	150	110	163	130
9/16"	18	71	57	120	90	150	110	170	130	181	144
5/8"	11	98	78	150	110	140	140	220	170	230	184
5/8"	18	115	93	180	130	210	160	240	180	255	204
3/4"	10	157	121	260	200	320	240	390	280	400	320
3/4"	16	160	133	300	220	380	280	420	320	440	350
7/8"	9	210	160	430	320	520	400	600	460	640	510
7/8"	14	230	177	470	360	580	440	650	500	700	560
1"	8	320	240	640	480	800	600	900	680	980	780
1"	12	350	265	710	530	860	666	900	740	1060	845

METRIC	5.8	8.8	9.8	10.9
Bolt Dia.	Oiled	Oiled	Oiled	Oiled
5mm	3.5	5	6	8
6mm	6	9	10.5	12
8mm	15	22	25	32
10mm	29	44	51	62
12mm	51	76	89	111